



8-2009

Countable Groups as Fundamental Groups of Compacta in Four-Dimensional Euclidean Space

Ziga Virk

University of Tennessee - Knoxville

Recommended Citation

Virk, Ziga, "Countable Groups as Fundamental Groups of Compacta in Four-Dimensional Euclidean Space." PhD diss., University of Tennessee, 2009.

https://trace.tennessee.edu/utk_graddiss/79

This Dissertation is brought to you for free and open access by the Graduate School at Trace: Tennessee Research and Creative Exchange. It has been accepted for inclusion in Doctoral Dissertations by an authorized administrator of Trace: Tennessee Research and Creative Exchange. For more information, please contact trace@utk.edu.

To the Graduate Council:

I am submitting herewith a dissertation written by Ziga Virk entitled "Countable Groups as Fundamental Groups of Compacta in Four-Dimensional Euclidean Space." I have examined the final electronic copy of this dissertation for form and content and recommend that it be accepted in partial fulfillment of the requirements for the degree of Doctor of Philosophy, with a major in Mathematics.

Jerzy Dydak, Major Professor

We have read this dissertation and recommend its acceptance:

Carl Sundberg, Morwen Thistlethwaite, Russell Zaretzki, Nikolay Brodskiy

Accepted for the Council:

Dixie L. Thompson

Vice Provost and Dean of the Graduate School

(Original signatures are on file with official student records.)

To the Graduate Council:

I am submitting herewith a dissertation written by Ziga Virk entitled “Countable Groups as Fundamental Groups of Compacta in four-Dimensional Euclidean space.”

I have examined the final electronic copy of this dissertation for form and content and recommend that it be accepted in partial fulfillment of the requirements for the degree of Doctor of Philosophy, with a major in Mathematics.

Jerzy Dydak

Major Professor

We have read this dissertation
and recommend its acceptance:

Carl Sundberg

Morwen Thistlethwaite

Russell Zaretzki

Nikolay Brodskiy

Accepted for the Council:

Carolyn R. Hodges

Vice Provost and Dean of
Graduate Studies

(Original signatures are on file with official student records.)

**Countable Groups as Fundamental
Groups of Compacta in
four-Dimensional Euclidean space**

A Dissertation

Presented for the

Doctor of Philosophy

Degree

The University of Tennessee, Knoxville

Ziga Virk

August 2009

Copyright © 2009 by Ziga Virk.
All rights reserved.

Acknowledgments

I would like to thank my advisor, Jerzy Dydak, for all the effort to guide me through the world of mathematics. His open mindedness and pursuit to understand ideas had equipped me with curiosity, so needed for successful work.

I would also like to express my gratitude to my committee, professors, fellow graduate students, family and friends for support in recent years.

Abstract

This dissertation addresses the question of realization of countable groups as fundamental groups of continuum.

In first chapter we discuss classical realizations in the category of CW complexes. We introduce Eilenberg-Maclane spaces and their topological properties.

The second chapter provides recent developments on realization question such as those of Shelah, Keesling, ...

The third chapter proves the realization theorem for countable groups. The resulting space is compact path connected, connected subspace of four dimensional Euclidean space.

Contents

1	Introduction	2
2	Algebraic Invariants in CW Category	4
2.1	CW Complexes and their Fundamental Group	4
2.2	Realizations of groups	6
3	Survey on Realization Results	9
3.1	Result of Shelah	9
3.2	Result of Keesling and Rudyak	10
4	Realization of Countable Groups	12
4.1	Introduction	12
4.2	Harmonic Vase and Peanifications	13
4.3	Wedges and Braiding HV 's	20
4.4	Attaching the Relations	28
4.5	Final Construction	33
	Bibliography	35
	Vita	37

List of Figures

4.1	Intersection of an HV with $\varphi \in \{0, \pi\}$	15
4.2	Intersection of an HV with $\varphi = \pm\pi/2$	15
4.3	The wall of an HV drawn in Maple.	16
4.4	Schematic representation of Peanification and strong deformation retract. Presented are the intersections with $\varphi \in \{0, \pi\}$	20
4.5	Schematic representation of two incorporated HV 's in BHV intersected with $\{\varphi = \pi\}$. Intersections are avoided using w -coordinate.	23
4.6	$P(BHV)$	28
4.7	Definition of a map f when attaching the disc.	32

Chapter 1

Introduction

The fundamental group is one of the most important concepts in topology, whose influence spread over other fields of mathematics, such as analysis, algebra, ... It was proven to be a good invariant not only in algebraic topology, but in more general aspect as well. As an example, it classifies all covering spaces in the category of semi-locally simply connected spaces. A famous "Poincaré conjecture" refers to similar classification issue: is 3–sphere the only compact 3–dimensional manifold without boundary with trivial fundamental group? Not surprisingly, a question of realization of arbitrary groups was a natural one.

It has been long known that every group can be realized as a fundamental group of two dimensional *CW* complex. The structure of *CW* complexes is excellent for implementation of algebraic structure in topology. The concept developed to Eilenberg-MacLane spaces which proved to be important spaces in research of homology, cohomology and spectral sequences.

While having nice algebraic properties, these spaces have less topological virtues. In general, they are not metric, locally compact, ... The natural generalization of *CW* realization would try to make realization nicer from the topological aspect. Surprising result of this kind was published by Shelah (7). Using forcing he proved the following

theorem.

Theorem 1. *Let X be a compact metric space which is path connected and locally path connected. If the fundamental group of X is not finitely generated, then it has the power of continuum.*

The same problem was studied by Pawlikowski (5) who also posed a question whether every finitely generated group can be realized as a fundamental group of continuum. In this dissertation we prove the following theorem.

Theorem 2. *For any countable group G there is a compact path connected subspace $X_G \subset \mathbb{R}^4$ so that $\pi_1(X_G, x_0) = G$.*

The theorem answers the question of Pawlikowski in more general aspect. It also greatly improves realizations of Keesling and Rudyak(4) and of Przeździecki (6) in case of countable groups.

Chapter 2

Algebraic Invariants in CW

Category

This chapter introduces CW complexes and provides some basic facts about realizations using CW complexes.

2.1 CW Complexes and their Fundamental Group

In homotopy theory, the class of primary interest consists of CW complexes.

Definition 3. *A space X is called CW **complex** (or cell complex) if it is constructed the following way:*

1. Let X^0 denote a discrete set of points.
2. Inductively define $X^n := X^{n-1} \cup_{\varphi} S_{\varphi}^n$ where every S_{φ}^n is an n -disc and $\varphi: \partial S_{\varphi}^n \rightarrow X^{n-1}$ is attaching map defined on it's boundary. Equip X^n with quotient topology. Hence X^n is obtained from X^{n-1} by gluing discs S_{φ}^n to X^{n-1} along attaching maps.
3. Define $X := \bigcup_n X^n$ and equip it with weak topology.

The set X^n is called n -**skeleton** of X .

The points of X^0 and sets $\varphi(S_\varphi^n - \partial S_\varphi^n) \subset X$ are called (open) **cells** and are usually denoted by e . Their attaching maps are denoted by φ_e . Note that X is a disjoint union of its open cells. Notation e^n means that cell is contained in $X^n - X^{n-1}$.

A closed subset $L \subset K$ is a **subcomplex** of K if it is disjoint union of open cells e_φ .

Remark. The structure of definition 3 has been generalized to m -stratified spaces in (8).

The CW complexes proved to be an ideal class to study homotopy theory. Their structure is flexible enough to be applied to most spaces of interest. Yet, their cell structure allows strong control of its homotopy type. This structure motivated the development of homology theory, cohomology theory and simplified study of manifolds. Here we list some basic properties of CW complexes.

Proposition 4. *Let K be a CW complex.*

1. *Subset $L \subset K$ is compact iff it is contained in a finite complex.*
2. *Complex K is compact iff it is finite.*
3. *If $L \subset K$ is a subcomplex, then $L \hookrightarrow K$ is a cofibration.*

Some of the most important properties of CW complexes refer to algebraic structures, the most important of which is the fundamental group.

Definition 5. *Let (X, x_0) be a pointed topological space. The **fundamental group** of X , denoted by $\pi_1(X, x_0)$, is the class of homotopy types of maps $(S^1, 0) \rightarrow (X, x_0)$.*

It is easy to see that this class of maps is a group indeed, group operation being concatenation. The cell structure of CW complexes makes it easy to express their fundamental group.

Theorem 6. Let (K, x) be a pointed, path connected CW complex with $K^1 - K^0 = \{e_i^1\}_i$ and $K^2 - K^1 = \{\partial e_j^2\}_j$. Then $\pi_1(K, x) = \langle \{e_i^1\}_i \mid \{\partial e_j^2\}_j \rangle$.

The proof of the theorem above uses cellular approximation theorem.

Definition 7. The map $f: (K, x) \rightarrow (L, y)$ between pointed CW complexes is **cellular** if $f(K^n) \subset L^n, \forall n$.

Theorem 8 (Cellular approximation theorem). Let $f: (K, x) \rightarrow (L, y)$ be a map between pointed CW complexes. Then f is homotopic to a cellular map g .

Both theorems were generalized for all dimensions.

Definition 9. Let (X, x_0) be a pointed topological space. The n^{th} **homotopy group** of X , denoted by $\pi_n(X, x_0)$, is the class of homotopy types of maps $(S^n, 0) \rightarrow (X, x_0)$.

For $n > 1$ homotopy groups π_n are Abelian.

Theorem 10. Let (K, x) be a pointed, path connected CW complex. Then $\pi_n(K, x) = \pi_n(K^{n+1}, x)$.

2.2 Realizations of groups

Theorem 6 provides a fairly simple mechanism to construct spaces with prescribed fundamental group. Using 10 and properties of wedge, Eilenberg-MacLane spaces were introduced.

Theorem 11. Given a group G and $n \in \mathbb{N}$, **Eilenberg-MacLane space** $K(G, n)$ is any space with $\pi_n K(G, n) = G$ and $\pi_m K(G, n) = 0, \forall m \neq n$.

In case $n > 1$ group G has to be Abelian for obvious reason. The theorem can easily be generalized.

Theorem 12. *Given group G_1 and Abelian groups $\{G_i\}_{i \geq 2}$ there exists a space X with $\pi_i(X) = G_i, \forall i$.*

Not surprisingly, all spaces that appear in such construction are CW complexes. Another homotopy invariants that behave nice with respect to CW structure are the homology groups. Imitating Eilenberg-MacLane spaces, Moore spaces arose as their counterpart for homology groups.

Theorem 13. *Given an Abelian group G and $n \in \mathbb{N}$, **Moore space** $M(G, n)$ is any space with $H_n M(G, n) = G$ and $H_m M(G, n) = 0, \forall m \neq n$.*

Theorem 14. *Given Abelian groups $\{G_i\}_{i \geq 1}$ there exists a space X with $H_i(X) = G_i, \forall i$.*

Even though their definition and construction are almost the same as that of Eilenberg-MacLane spaces, Moore spaces do not quite reach their importance as the next theorem suggests. In particular, homotopy classes of maps from a CW complex to Eilenberg-MacLane spaces are closely connected with the cohomology groups of that complex.

Theorem 15. *For every Abelian group G , and every CW complex K , the set $[K, K(G, n)]$ of homotopy classes of maps from X to $K(G, n)$ is in natural bijection with $H^n(X, G)$.*

Even though Eilenberg-MacLane spaces provide us realizations of groups as homotopy groups of spaces, they mostly fail to be metric or compact. The following two theorems explain how realizations can be made metric.

Theorem 16. *Every countable CW complex is homotopy equivalent to a locally finite CW complex.*

Theorem 17. *Every countable locally finite CW complex is metrizable.*

In case of countable groups these theorems provide a metric realizations. However the realizations are not compact. In next chapter we will mention a procedure introduced in (4) and (6) that provides us with compact realizations. However that realization is not metric so the problem of realization of countable group by compact metric space remains unsolved using these techniques.

Chapter 3

Survey on Realization Results

In this chapter we present recent developments on the field of realizations. First we discuss the theorems of Shelah (7) and (5) which state that the fundamental group of mice spaces is either finitely generated or has the power of continuum. What follows are results of Keesling, Rudyak (4) and Przeździecki (6) concerning compact realizations.

3.1 Result of Shelah

Shelah proved the following result.

Theorem 18. *Let X be a compact metric space which is path connected and locally path connected. If the homotopy group of X is not finitely generated then it has the power of the continuum (in fact there is a perfect set of non-homotopic loops in the fundamental group).*

In particular, the fundamental group of compact metric path connected and locally path connected space can't be \mathbb{Q} or any other countable group, that is not finitely generated. This means that the realizations of such groups, if compact metric path connected, can't be locally path connected. Therefore the realizations of the

theorem 39 will not be path connected. This certainly presents some difficulty when calculating the fundamental group but can be bypassed using Peanification, as will be presented in the next chapter.

How does Shelah prove his theorem? He considers the fundamental group of compact metric space which is path connected and locally path connected. If it is not finitely generated, then there is a point that contains arbitrarily small loops. The set of such loops is subject to certain infinite product, that can be applied to certain sequences of such loops. Using forcing, he then proves that such infinite product provides a space with a perfect set of loops, which implies that their cardinality is more than $|\mathbb{N}|$.

Following his idea, Pawlikowski proved the same result without forcing. Also he posed a question about the realization of finitely generated groups. The generalization of his question is answered in affirmative way in the next chapter.

3.2 Result of Keesling and Rudyak

Another approach was presented by Keesling and Rudyak. Their goal was to realize arbitrary groups with compact spaces. Their idea is to consider the path component of the Stone-Ćech compactification and prove that it's fundamental group is the same as that of the original space.

Theorem 19. *If X is a path connected paracompact space of non-measurable cardinality, then X is a path component of βX .*

Theorem 20. *Every group of non-measurable cardinality is the fundamental group of a compact space.*

Their ideas were studied by Przeździecki, who improved the realization result by making the space path connected.

Theorem 21. *Any group G of nonmeasurable cardinality is the fundamental group of a path connected compact space Z .*

Such realizations, however, arise from Stone-Čech compactifications and are hence non-metrizable.

Chapter 4

Realization of Countable Groups

4.1 Introduction

In this section we deal with the problem of creating a compact space X_G with a given fundamental group G . That problem was discussed in papers (7), (5), and (4). Shelah (7) proved G must be finitely generated if G is countable and X_G is a Peano continuum. An alternative proof of that result was presented by Pawlikowski (5) who posed the reverse question:

Problem 22 (Pawlikowski). *Given a finitely generated group G is there a continuum X_G such that $\pi_1(X_G) = G$.*

Keesling and Rudyak (4) addressed the case of groups G for which X_G can be chosen as compact Hausdorff. Namely, every group of non-measurable cardinality is the fundamental group of a compact space. However, their construction yields non-metrizable and non-path connected spaces, so they posed the following question in the electronic version of their paper:

Problem 23 (Keesling and Rudyak). *For which groups G is there a path-connected compact Hausdorff X_G such that $\pi_1(X_G) = G$?*

Adam Przeździecki (6) answered 23 in affirmative for any G of non-measurable cardinality. Also, he announced an example of an abelian group of measurable cardinality that is not the fundamental group of any compact space.

A natural idea when constructing a space with prescribed fundamental group G is to realize it as a two dimensional CW complex K_G . Theorem 6 provides a fairly simple mechanism to construct space with prescribed fundamental group. In case of general countable or even finitely generated group K_G may not be metric or compact. In the case of G being countable we plan to construct a compact metric space X_G with the fundamental group isomorphic to G . The idea is to replace 1-cells (using a variation of smallness property (8)) by suitable spaces which will enable our construction to take place in \mathbb{R}^4 . Such replacement will allow us to make our space compact but we will lose local path connectedness and universal property for extending maps that K_G has: any homomorphism $G \rightarrow \pi_1(Y)$ induces $K_G \rightarrow Y$ for any space Y .

4.2 Harmonic Vase and Peanifications

The basic step in our construction is the Harmonic Vase. It replaces 1-cells in the construction of K_G . Definition 24 introduces HV as a subspace of \mathbb{R}^3 . Later in 31 it will be redefined to be a subset of \mathbb{R}^4 to comply with the needs of construction of realization.

Definition 24. *The **Harmonic Vase** with parameters $m, p \in \mathbb{R}^+$ [notation: $HV(m, p)$] is the subset of \mathbb{R}^3 defined as the union of two sets:*

- the **pedestal** defined as $B(3, 0) \cap (\mathbb{R}^2 \times \{0\}) = \{(x, y, 0) \in \mathbb{R}^3, x^2 + y^2 \leq 9\} = \{r \leq 3, z = 0\}$, and

- the **wall** $W(m, p)$, parameterized as

$$z \in (0, m], \quad \varphi \in [-\pi, \pi], \quad r := \frac{|\varphi|}{\pi} \sin \frac{\pi p}{z} + 2$$

where (r, φ) are polar coordinates in $\mathbb{R}^2 \times \{0\} \subset \mathbb{R}^3$ and z is the coordinate of $\{0\}^2 \times \mathbb{R}$ so that (r, φ, z) are cylindric coordinates in \mathbb{R}^3 .

Figures 4.1, 4.2 and 4.3 provide visualization for Harmonic Vase. For the sake of simplicity we will use the notation HV instead of $HV(m, p)$ if the parameters don't play any crucial role.

Using cylindrical coordinates, we will always assume $\varphi \in [-\pi, \pi]$. To visualize the wall of HV note that for any fixed $a \neq 0, a \in [-\pi, \pi]$ the intersection of the wall and halfplane $\varphi = a$ in \mathbb{R}^3 is a reparameterized $\sin \frac{1}{x}$ curve. In case $a = 0$ we get a semi open line segment.

The parameter m in $HV(m, p)$ is the height of the Harmonic Vase, the parameter p determines a parametrization of $\sin \frac{1}{x}$ curving of the wall. We will vary both of these in our construction.

Proposition 25. *Every HV is compact.*

Proof. Take any Cauchy sequence S in HV . If S converges to a point in \mathbb{R}^3 with $z = 0$ then that limit point is contained in the pedestal of HV . If S converges to a point in \mathbb{R}^3 with $z > 0$ then we may assume that all points of S have z -coordinate at least ε for some fixed $\varepsilon > 0$. Because $HV \cap \{z \geq \varepsilon\}$ is compact (by the definition it is the image of $[\varepsilon, m] \times [-\pi, \pi]$ under a continuous function) and contains S , it also contains the limit point. ■

When constructing the realization space X_G , we will use HV 's with various parameters. In order to combine them efficiently we have to introduce the notion of inner-curves of $HV(m, p)$.

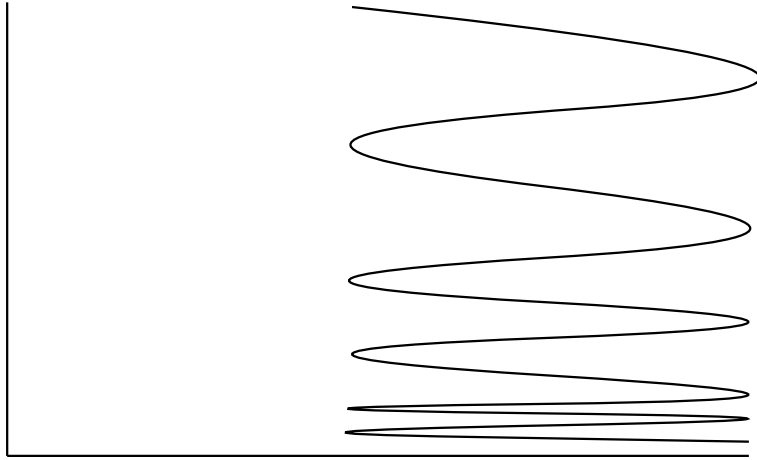

Figure 4.1: Intersection of an HV with $\varphi \in \{0, \pi\}$.

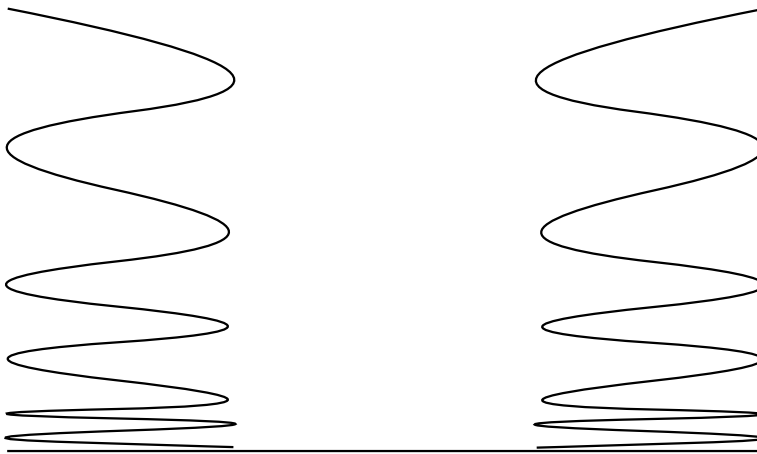

Figure 4.2: Intersection of an HV with $\varphi = \pm\pi/2$.

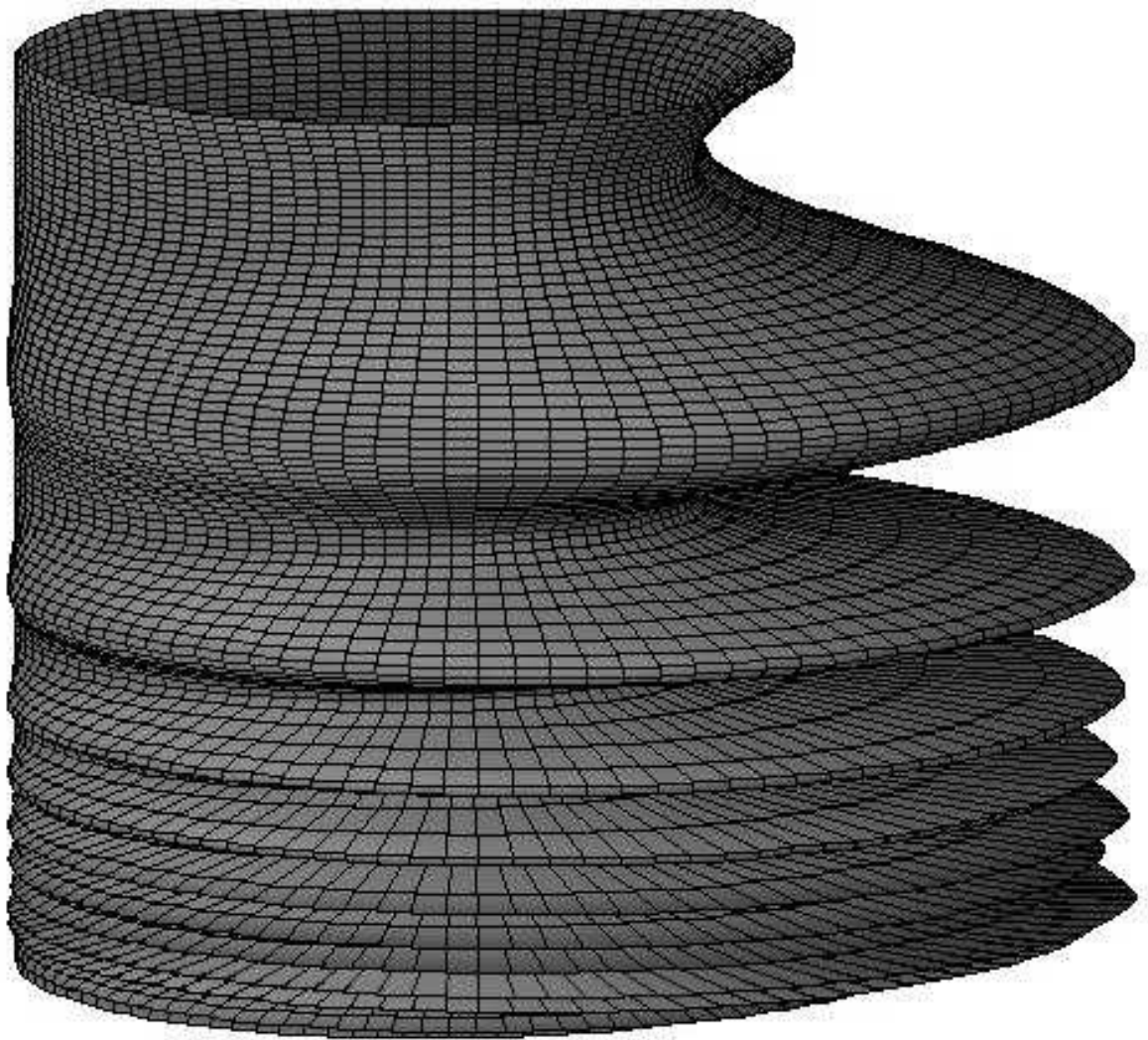

Figure 4.3: The wall of an HV drawn in Maple.

Definition 26. The *inner-heights* of $HV(m, p)$ are numbers $\{h \in \mathbb{R}^+ \mid \sin(\frac{\pi p}{h}) = -1\}$. The *inner-curves* are simple closed curves $S(m, p, c) := HV(m, p) \cap \{z = c\}$ where $c \in (0, m]$ is any height.

For any fixed $a \in (0, m]$ the orthogonal projection of the curve $S(m, p, a)$ to $\mathbb{R}^2 \times \{0\}$ is parameterized as

$$R = \frac{|\Phi|}{\pi} \sin \frac{\pi p}{a} + 2, \Phi \in [-\pi, \pi],$$

where (R, Φ) are polar coordinates in \mathbb{R}^2 . For any two choices of a , these curves are smooth topological circles that either have the only common point at $\Phi = 0$ (in which case one of the curves lies inside the set bounded by the other curve) or they are same hence we can talk about some of these curves being inner or outer. The meaning of inner-heights is to provide the set of heights, for which these projections are inner-most curves.

As mentioned above, HV 's replace S^1 in the construction of CW countable group realization. It is hence important to know it's fundamental group. For this purpose we recall the definition of the universal Peano space introduced in (1).

Definition 27. Let X be a path connected space. The *universal Peano space* of X [notation: $P(X)$] is the set X equipped with a new topology, generated by all path-components of all open subsets of the existing topology on X . The *universal Peano map* is the natural bijection $P(X) \rightarrow X$.

The name "universal Peano map" refers to the universal map lifting property for locally path connected spaces:

Proposition 28. Let Y be a locally path connected space. Then any map $f: Y \rightarrow X$ uniquely lifts to a map $g: Y \rightarrow P(X)$.

$$\begin{array}{ccc}
& & P(X) \\
& \nearrow g & \downarrow \\
Y & \xrightarrow{g} & X
\end{array}$$

Proof. The universal Peano map is a bijection which gives us an obvious unique lift. To prove it is continuous take any $y \in Y$ and assume $V \subset P(X)$ is a path component of an open subset $W \subset X$ with $f(y) \in V$. Then there exists an open path connected neighborhood $U \subset Y$ of y so that $f(U) \subset W$, hence $f(U) \subset V$ as $f(U)$ is path connected. Thus g is continuous. ■

Note that if Y is locally path connected then so is $Y \times I$ (where $I := [0, 1]$) which yields the following corollary.

Corollary 29. *Let Y be locally path connected space and let X be path connected space.*

1. *The set of homotopy classes of maps $[Y, X]$ is in a natural bijection with $[Y, P(X)]$.*
2. *The set of homotopy classes of maps $[Y, X]_{\bullet}$ in the pointed category is in a natural bijection with $[Y, P(X)]_{\bullet}$.*
3. *$\pi_k(X) = \pi_k(P(X))$, for all $k \in \mathbb{Z}^+$.*

Using peanification one can easily compute the fundamental groups of HV .

Proposition 30. *For every choice of parameters m, p one has $\pi_*(HV(m, p)) = \pi_*(S^1)$. Moreover, the inclusion of the top edge of HV into HV is a weak homotopy equivalence.*

Proof. To simplify the notation in this proof we will use notation HV instead of $HV(m, p)$.

The crucial step is to extract space $P(HV)$. We have to consider four different types of points.

1. Every point of the wall of HV has arbitrarily small simply connected neighborhood as the wall itself is homeomorphic to $S^1 \times (0, 1]$. Hence the topology of $P(HV)$ at those points is no different from the topology in HV .
2. The point $(z = 0, \varphi = 0, r = 2)$ (we will mark that point with x_0) also has arbitrarily small simply connected neighborhood, which is a bit harder to see. Let $\varepsilon > 0$ be sufficiently small and consider neighborhood U_ε of x_0 in HV that contains all points with $z < \varepsilon, |\varphi| < \varepsilon, 2 + \varepsilon > r > 2 - \varepsilon$. We will show that any point $x \in U_\varepsilon$ can be connected to x_0 by a path which is enough for the proof of our claim.

If the z -coordinate of x equals 0 then x can be connected to x_0 because the pedestal (that contains both x_0 and x) is locally path connected.

If the z -coordinate of x equals $h \neq 0$ then $U_\varepsilon \cap \{z = h\}$ is an open arc, containing path from x to a point $(z = h, \varphi = 0, r = 2)$. This point can be connected to x_0 in H_ε by a straight line segment.

3. The points on pedestal with $r > \frac{|\varphi|}{\pi} + 2$ or $r < -\frac{|\varphi|}{\pi} + 2$ are not limit points of the wall. Hence they all have arbitrarily small simply connected neighborhood.
4. The points on pedestal with $\frac{|\varphi|}{\pi} + 2 \geq r \geq -\frac{|\varphi|}{\pi} + 2$ are limit points of the wall. But any point x , other than x_0 has a neighborhood U_x small enough, so that the path component of U_x containing x lies in the pedestal.

Summing up, the only change of topology happens at the points in (iv) which become separated from the wall: they have neighborhoods contained only in the pedestal. This means that $P(HV)$ is homeomorphic to a wedge $B^2 \vee \left((S^1 \times (0, 1]) \cup \right.$

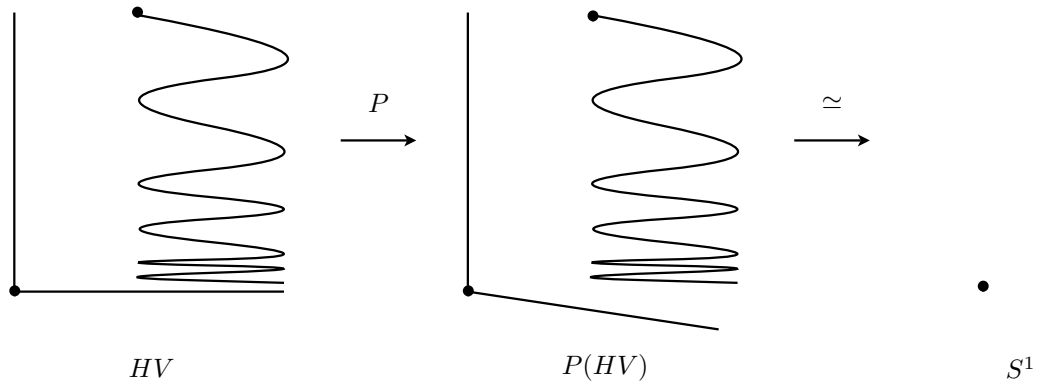

Figure 4.4: Schematic representation of Peanification and strong deformation retract. Presented are the intersections with $\varphi \in \{0, \pi\}$.

$\{x_0\}$) where B^2 corresponds to pedestal, wedge point represents x_0 and $S^1 \times (0, 1]$ corresponds to the wall of HV . There is a strong deformation retraction $P(HV) \rightarrow S^1$. Using homotopic equivalence $P(HV) \simeq S^1$ as described by 29 and Figure 4.4 we get $\pi_*(HV) \cong \pi_*(S^1)$. ■

4.3 Wedges and Braiding HV 's

The next step is to take a countable union of Harmonic Vases, each of which will correspond to one generator of the group G . While doing so we have to be careful to maintain compactness, inner-heights of every HV and to avoid intersections of different vases except at pedestal and at $\varphi = 0$. Compactness will be preserved by decreasing the height of vases (namely decreasing m). Inner-heights will be different for suitable choice of parameters p (namely they have to be algebraically independent over \mathbb{Q}). Intersections will be avoided using additional Euclidean dimension. Let us first introduce the notation that will explain how HV 's are embedded in \mathbb{R}^4 .

Definition 31. *Harmonic Vase* with parameters $m, p \in \mathbb{R}^+$ and $w: [-\pi, \pi] \times$

$(0, m] \rightarrow \mathbb{R}$ [notation: $HV(m, p, w)$] is the subset of \mathbb{R}^4 defined as the union of two sets:

- the pedestal $B(3, 0) \cap (\mathbb{R}^2 \times \{0\}^2) = \{(x, y, 0, 0) \in \mathbb{R}^4, x^2 + y^2 \leq 9\}$, and
- the wall $W(m, p, w)$, parameterized as

$$z \in (0, m], \quad \varphi \in [-\pi, \pi], \quad r := \frac{|\varphi|}{\pi} \sin \frac{\pi p}{z} + 2, \quad w := w(\varphi, z),$$

where (r, φ) are polar coordinates in $\mathbb{R}^2 \times \{0\}^2 \subset \mathbb{R}^4$, z is the coordinate representing $\{0\}^2 \times \mathbb{R} \times \{0\}$ so that (r, φ, z) are cylindric coordinates in $\mathbb{R}^3 \times \{0\}$ and w is the fourth coordinate representing $\{0\}^3 \times \mathbb{R}$.

We define Braided Harmonic Vase (BHV) inductively. Let $\{p_i\}_{i \in \mathbb{Z}^+}$ be a sequence of positive numbers that are pairwise algebraically independent over \mathbb{Q} meaning that p_i and p_j are algebraically independent over \mathbb{Q} for every choice of $i \neq j$. To handle the intersections let us describe them first. For $j < i; j, i \in \mathbb{Z}^+$ define

$$H_i^j := \{x \mid W(\frac{1}{i}, p_i) \cap W(\frac{1}{j}, p_j) \cap (\mathbb{R}^2 \times \{x\}) \neq \emptyset\}.$$

In other words, H_i^j is set of all heights where $W(\frac{1}{i}, p_i)$ and $W(\frac{1}{j}, p_j)$ intersect. Note that each of these sets is discrete in $(0, \frac{1}{i}]$: algebraic independence guarantees that no inner-height of $W(\frac{1}{i}, p_i)$ is in H_i^j , inner-heights converge to 0 and there are only finitely many elements of H_i^j between two any two inner-heights. Consequently the finite union $H_i := \cup_{j < i} H_i^j$ is discrete. Hence there exist functions

$$w_i: (0, \frac{1}{i}] \rightarrow [0, \frac{1}{i}]$$

with the following properties:

$$w_i(x) < x \quad \forall x; \tag{4.1}$$

$$w_i(x) \neq w_j(x) \quad \forall j < i, \forall x \in H_i^j; \tag{4.2}$$

$$w_i \equiv 0 \text{ on some neighborhood of inner-heights.} \tag{4.3}$$

As we already mentioned, the first condition maintains compactness, the second one allows us to avoid intersections and the third one preserves neighborhoods of inner-curves in \mathbb{R}^3 .

Definition 32. Let $\{p_i\}_{i \in \mathbb{Z}^+}$ be a sequence of positive numbers that are pairwise algebraically independent over \mathbb{Q} and let $w_i: (0, \frac{1}{i}] \rightarrow [0, \frac{1}{i}]$ be a set of functions satisfying (4.1) and (4.3). **Braided Harmonic Vase** with parameters $\{p_i, w_i\}_i$ [notation: $BHV(\{p_i, w_i\}_i)$] is

$$\bigcup_{i \in \mathbb{Z}^+} HV(\frac{1}{i}, p_i, |\varphi|w_i).$$

The **wall** of BHV is union of the walls of Braided HV 's. The **pedestal** of BHV is the pedestal of any (every) Braided HV 's.

Figure 4.5 gives the sketch of BHV . Note that the function $|\varphi|w_i$ allows us to avoid intersections between HV 's except at $\varphi = 0$. We now need to prove that every BHV is compact and calculate its fundamental group.

Proposition 33. *Every BHV is compact.*

Proof. Take any Cauchy sequence S in BHV . If S converges to a point in \mathbb{R}^4 with $z = 0$ then because $w < z$ (the fourth coordinate is less than the third one by (4.1)) that limit point is contained in pedestal of HV . If S converges to a point in \mathbb{R}^4 with $z > 0$ then we can assume that all points of S have z -coordinate at least ε for some

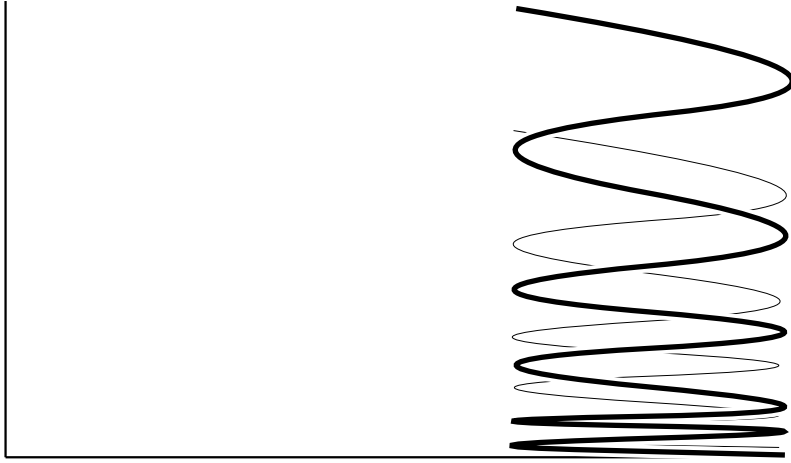

Figure 4.5: Schematic representation of two incorporated HV 's in BHV intersected with $\{\varphi = \pi\}$. Intersections are avoided using w -coordinate.

fixed $\varepsilon > 0$. Because $HV \cap \{z \geq \varepsilon\}$ is compact (by the definition it is finite union of images of $[\varepsilon, \frac{1}{i}] \times [-\pi, \pi]$ as the heights of braided HV 's are decreasing) and contains S , it also contains the limit point. ■

Remark. Note that BHV and HV are intersections of decreasing sequence of compacts, namely their closed $1/i$ -neighborhoods. This fact gives alternative proof of compactness.

At this point we should emphasize the difference between a weak wedge and a metric wedge. Suppose $(X_i, x_i, d_i)_{i \in \mathbb{Z}^+}$ is a countable collection of pointed metric spaces with $x_i \in X_i$. Their **weak wedge** $\vee_{\mathbb{Z}^+} X_i$ is quotient space obtained by identifying all points x_i . Their **metric wedge** $\vee_{\mathbb{Z}^+}^m X_i$ is a metric space obtained by identifying all points x_i and defining the metric d_\vee in the following way:

- if $x, y \in X_j \subset \vee_{\mathbb{Z}^+}^m X_i$ for some $j \in \mathbb{Z}^+$ then $d_\vee(x, y) := d_j(x, y)$;
- else $d_\vee(x, y) := d_j(x, x_j) + d_k(y, x_k)$ where $x \in X_j \subset \vee_{\mathbb{Z}^+}^m X_i$, $y \in X_k \subset \vee_{\mathbb{Z}^+}^m X_i$.

The definition makes sense as $\vee_{\mathbb{Z}^+}^m X_i$ is pointwise union of sets X_i . It is easy to prove that d_\vee is indeed a metric.

In general $\vee_{\mathbb{Z}^+} X_i$ will almost never be metric because of the topology at the wedge point. However, the topologies on natural subspaces X_i are preserved by both wedges. Lemma 36 proves that in many cases the homotopy types of maps from compact space to both wedges coincide.

Definition 34. *Suppose (X, x_0) is a pointed metric space. A **strong deformation contraction** of X to x_0 , is a continuous map $H: X \times I \rightarrow X$ so that*

1. $H|_{X \times \{0\}} = 1|_X$;
2. $H(X \times \{1\}) = H(\{x_0\} \times I) = x_0$;
3. $d(H(x, t), H(y, t)) \leq d(x, y), \forall t \geq 0$.

Remark. The use of this definition will be demonstrated in the proof of 36 as the metric wedge of strong deformation contractions is automatically continuous strong deformation contraction. Note that metric wedge of strong deformation retractions needs not be a continuous map, it may fail to be continuous at the wedge point.

Lemma 35. *Suppose that $R_i: X_i \rightarrow \{x_i\}$ are strong deformation contractions of pointed metric spaces (X_i, x_i) . Then the naturally defined map $R := \vee_i R_i: \vee_i^m X_i \rightarrow \vee_i^m \{x_i\}$ on a metric wedge is strong deformation contraction.*

Proof. We only need to show continuity of R . Let $\{y_i\}_i = \{(p_i, t_i)\}_i$ be a Cauchy sequence of points in $\vee_i^m X_i \times I$ with limit $y = (p, t)$. If $y \in X_k - \{x_k\} \times I$ for some k then $\lim_{i \rightarrow \infty} R(y_i) = R(y)$ as R restricts to continuous R_k . If $y \in \vee_i^m \{x_i\} \times I$ then by definition 34

$$d(D(y_i), D(y)) = d(D(p_i, t_i), D(\vee_i^m \{x_i\}, t_i)) \leq d(p_i, \vee_i^m \{x_i\}) \rightarrow_{i \rightarrow \infty} 0.$$

Hence D is continuous. ■

Lemma 36. *Let $r > 0$ and suppose that for each $i \in \mathbb{Z}^+$ the r -neighborhood $U_i \subset X_i$ of point $x_i \in X_i$ in a metric space (X_i, d_i) retracts to x_i via strong deformation contraction R_i . Then for each pointed compact space (K, k_0) there is a natural bijection of homotopy classes of pointed maps $[K, \vee_{\mathbb{Z}^+} X_i] = [K, \vee_{\mathbb{Z}^+}^m X_i]$.*

Proof. The natural map $\vee_{\mathbb{Z}^+} X_i \rightarrow \vee_{\mathbb{Z}^+}^m X_i$ is continuous hence we have a natural inclusion of the sets of maps $\mathcal{C}(K, \vee_{\mathbb{Z}^+} X_i) \subset \mathcal{C}(K, \vee_{\mathbb{Z}^+}^m X_i)$ and $\mathcal{C}(K \times I, \vee_{\mathbb{Z}^+} X_i) \subset \mathcal{C}(K \times I, \vee_{\mathbb{Z}^+}^m X_i)$ which induce a well defined map $[K, \vee_{\mathbb{Z}^+} X_i] \rightarrow [K, \vee_{\mathbb{Z}^+}^m X_i]$. We will show that this map is a bijection.

First we prove that every map $f: (K, k_0) \rightarrow (\vee_{\mathbb{Z}^+}^m X_i, x_0)$ is homotopic *rel* k_0 to a map $g: (K, k_0) \rightarrow (\vee_S^m X_i, x_0) \subset (\vee_{\mathbb{Z}^+}^m X_i, x_0)$ for some finite subset $S \subset \mathbb{Z}^+$. The finite metric and weak wedges coincide hence g can naturally be considered as a map to $\vee_{\mathbb{Z}^+} X_i$.

Let $f: (K, k_0) \rightarrow (\vee_{\mathbb{Z}^+}^m X_i, x_0)$ be a map. The sets $X_i - U_i \subset \vee_{\mathbb{Z}^+}^m X_i$ are $2r$ disjoint hence there exists $n \in \mathbb{N}$ so that compact $f(K)$ has empty intersection with $X_i - U_i$ for all $i \geq n$. Let D be naturally defined homotopy on metric wedge

$$X_1 \vee X_2 \vee \dots \vee X_{n-1} \vee U_n \vee U_{n+1} \vee \dots \subset \vee_{\mathbb{Z}^+}^m X_i$$

so that $D(x, t) := x, \forall x \in X_1 \vee X_2 \vee \dots \vee X_{n-1}$ and $D(x, t) := R_i(x, t)$ for all $x \in U_i, i \geq n$. Note that map $(x, t) \mapsto D(f(x), t)$ defined on $K \times I$ is a homotopy *rel* k_0 between f and the map g whose image is contained in $\vee_{i < n} X_i$. Hence g can be considered as a representative of $[f]$ in $[K, \vee_{\mathbb{Z}^+} X_i]$ which means that $[K, \vee_{\mathbb{Z}^+} X_i] \rightarrow [K, \vee_{\mathbb{Z}^+}^m X_i]$ is surjective. Using the same argument for space $K \times I$ we also see that $\vee_{\mathbb{Z}^+} X_i \rightarrow \vee_{\mathbb{Z}^+}^m X_i$ implies surjection on homotopies which means that $[K, \vee_{\mathbb{Z}^+} X_i] \rightarrow [K, \vee_{\mathbb{Z}^+}^m X_i]$ is injection hence bijection is proved. ■

Proposition 37. $\pi_*(BHV) = \pi_*(\vee_{\mathbb{Z}^+} S^1)$.

Proof. Again the crucial step is to extract the space $P(BHV)$. The proof is almost the same as that of 30

1. Every point of the wall of BHV has arbitrarily small simply connected neighborhood as the wall itself is homeomorphic to a countable union (in \mathbb{R}^4) of $S^1 \times (0, 1]$ with common line $\{1 \times I\}$. Hence the topology of $P(BHV)$ at those points is no different from the topology in BHV .
2. The point $(z = 0, \varphi = 0, r = 2, w = 0)$ (we will mark that point with x_0) also has arbitrarily small simply connected neighborhood. Let $\varepsilon > 0$ be very small and consider neighborhood U_ε of x_0 in BHV that contains all points with $z < \varepsilon$, $|\varphi| < \varepsilon$, $2 + \varepsilon > r > 2 - \varepsilon$. We will show that any point $x \in U_\varepsilon$ can be connected to x_0 by a path which is enough for the proof of our claim.

If the z -coordinate of x equals 0 then x can be connected to x_0 because the pedestal (that contains both x_0 and x) is locally simply connected.

If the z -coordinate of x equals $h \neq 0$ then $U_\varepsilon \cap \{z = h\}$ is a finite wedge of open arcs, containing path from x to a point $(z = zh, \varphi = 0, r = 2)$. This point can be connected to x_0 in H_ε by a straight line segment.

3. The points on pedestal with $r > \frac{|\varphi|}{\pi} + 2$ or $r < -\frac{|\varphi|}{\pi} + 2$ are not limit points of the wall. Hence they all have arbitrarily small simply connected neighborhood.
4. The points on pedestal with $\frac{|\varphi|}{\pi} + 2 \geq r \geq -\frac{|\varphi|}{\pi} + 2$ are limit points of the wall. But any point x , other than x_0 has a neighborhood U_x small enough, so that the path component of U_x containing x lies in the pedestal.

Summing up, the only change of topology happens at the points in (iv) which become separated from the wall: they have neighborhoods contained only in the pedestal. This means that $P(BHV)$ is homeomorphic to a wedge $B^2 \vee (\cup_{i \in \mathbb{Z}^+} W_i \cup$

$\{x_0\}$) where B^2 represents pedestal, wedge point represents x_0 and $(\cup_{i \in \mathbb{Z}^+} W_i)$ is the wall of BHV (each W_i represents the wall of some HV braided in BHV). Such space is represented by Figure 4.6.

Notice that the family $\{W_i\}_i$ is locally finite everywhere except at x_0 . The union $\cup_i W_i$ in $P(BHV)$ can be replaced by a homeomorphic space: union of semi-open lateral sides of cylinders of increasing radius and decreasing height. To make the notation formal let $S(r, h) \subset \mathbb{R}^3$ be semi-open lateral side of cylinder of radius r , height h based at $(r, 0, 0) \in \mathbb{R}^3$:

$$S(r, h) = \{(x, y, z) \in \mathbb{R}^3 \mid z \in (0, h]; d_{\mathbb{R}^2}((x, y), (r, 0)) = r\}.$$

Using this notation

$$P(BHV) \cong \left(B^2 \vee (\cup_{i \in \mathbb{Z}^+} S(2 - \frac{1}{i}, \frac{1}{i}) \cup \{x_0\}) \right)$$

where naturally $x_0 = (0, 0, 0) \in \mathbb{R}^3$.

Using the obvious strong deformation retraction we see that

$$P(BHV) \simeq V := \cup_i \{(x, y) \in \mathbb{R}^2 \mid d_{\mathbb{R}^2}((x, y), (2 - \frac{1}{i}, 0)) = 2 - \frac{1}{i}\}.$$

Using 36 we get a natural bijection of homotopy classes of maps $[K, V] = [K, \vee_{\mathbb{Z}^+} S^1]$ for any compact space K . This bijection and 29 imply $\pi_*(BHV) \cong \pi_*(\vee_{\mathbb{Z}^+} S^1)$. ■

Remark. Note that the space V is not homeomorphic to a countable wedge of circles, it is homeomorphic to countable metric wedge of circles as the topology is not second countable.

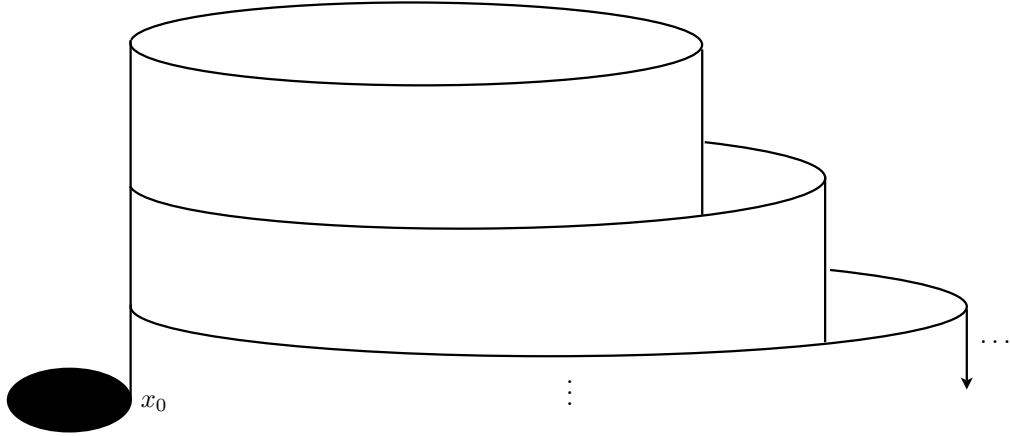

Figure 4.6: $P(BHV)$.

4.4 Attaching the Relations

We have constructed a compact metric space BHV so that $\pi_1(BHV) = \langle g_1, g_2, \dots \rangle$. In this subsection we will attach a disc B^2 to a space BHV so that compactness will be preserved and the fundamental group will change to $\langle g_1, g_2, \dots \mid r_1 \rangle$. The following lemma explains how to attach a disc B^2 to BHV at a certain "height" so that $BHV \cup B^2$ remains a subspace of \mathbb{R}^4 . Recall that (z, w) stands for the pair of third and fourth Cartesian coordinates in \mathbb{R}^4 respectively.

Notation. For every $x, y \in \mathbb{R}^+$ define:

- $z_x := (r = 2, \varphi = 0, z = x, w = 0)$;
- γ^x is the linear path from $x_0 = z_0$ to z_x ;
- γ_y^x is the linear path from z_y to z_x .

We will consider fundamental groups of HV 's and BHV based at various points z_h . All the isomorphisms between differently based fundamental groups will be induced by paths γ^* and γ_*^* .

Lemma 38. *Suppose $H = \cup_{i \in \mathbb{Z}^+} HV_i$ is a Braided Harmonic Vase where HV_i are naturally incorporated Harmonic Vases. Let $h \in \mathbb{R}^+$ and $r = [g_1 g_2 \dots g_k] \in \pi_1(H, z_h)$ where each $[g_i]$ denotes one of two generators of some $[\gamma^h]^{-1} * \pi_1(HV_{j(i)}, x_0) * [\gamma^h]$. Then there exists $l \in \mathbb{R}^+$ and an open topological 2–disc D so that:*

1. $D \subset \{h \geq z \geq l\} \subset \mathbb{R}^4$
2. $H \cap D = \emptyset$;
3. $H \cup D \subset \mathbb{R}^4$ is naturally homeomorphic to $H \cup_r B^2$.

Remark. Parameters h and l allow us to attach B^2 to desired relation on H as low (in terms of positive z –coordinate) as necessary. For this purpose the loop $g_1 g_2 \dots g_k$ is based at z_h as the loop along which we attach the disc should be contained in $\{h \geq z \geq l\}$.

Proof. First we will define a path α in $H \cap \{h \geq z \geq l\}$ so that:

- $\alpha(0) := z_h$;
- $\alpha(1) = z_l$ for some $0 < l \leq h$;
- $[\alpha * \gamma_l^h] = r \in \pi_1(H, z_h)$.

The construction of α is essentially a concatenation of two types of paths: vertical paths γ_*^* (changing only the z –coordinate) and generators of $\pi_1(W_i)$ near inner-heights.

Constructing the path

Define $\alpha(0) := z_h$ and let $a_1 < h$ be an inner-height of $HV_{j(1)}$. Define $\alpha_1(t) := \gamma_{z_{a_1}}^{z_h}(1 - t)$. Note that the image of α_1 is contained in H . Appropriate orientation of a topological circle $HV_{j(1)} \cap \{z = a_1\}$ based at z_{a_1} is a loop that represents $[\gamma_{z_{a_1}}^h * g_1 *$

$(\gamma_{z_{a_1}}^h)^{-1}] \in \pi_1(H, z_{a_1})$. Let β'_1 denote such loop based at z_{a_1} , i.e. $[\beta'_1] = [\gamma_{z_{a_1}}^h * g_1 * (\gamma_{z_{a_1}}^h)^{-1}] \in \pi_1(H, z_{a_1})$.

We still want to do a small correction of β'_1 . We want the function $t \mapsto \pi_z(\beta'_1(t))$ to be decreasing where π_z is projection to z -axis. The meaning of this condition will be explained later. Recall the meaning of the function $w_{j(1)}$ from the definition of *BHV* 32. The function $w_{j(1)}$ equals 0 on a neighborhood U_1 of $a_1 \in \mathbb{R}$. It is not hard to see that we can homotope β'_1 to another path (denote it by β_1) in $HV_{j(1)}$ just by slightly changing z -coordinates within U_1 (decrease z along β'_1) so that we preserve starting point $\beta'_1(0) = \beta_1(0)$, make $t \mapsto \pi_z(\beta_1(t))$ decreasing function and $[\beta'_1] = [\beta_1 \gamma_{\beta_1(1)}^{a_1}] \in \pi_1(H, a_1)$.

We proceed by induction: let $a_2 < \beta_1(1)$ be an inner-height of $HV_{j(2)}$. Define path $\alpha_2(t) := \gamma_{z_{a_2}}^{\beta_1(1)}(1-t)$. The correct orientation of the topological circle $HV_{j(2)} \cap \{z = a_2\}$ based at z_{a_2} represents $[\gamma_{z_{a_2}}^h * g_2 * (\gamma_{z_{a_2}}^h)^{-1}] \in \pi_1(H, z_{a_2})$. Let β'_2 denote such loop based at z_{a_2} . Again we perturb β'_2 to path β_2 so that $t \mapsto \pi_z(\beta_2(t))$ is decreasing and $\beta'_2(0) = \beta_2(0)$.

Having defined paths α_i (connecting paths) and β_i (paths that represent r_i) for every $i \in \{1, \dots, k\}$ we concatenate them to get α :

$$\alpha := \alpha_1 * \beta_1 * \alpha_2 * \beta_2 * \dots * \alpha_k * \beta_k$$

Note that such defined α satisfies required conditions: $\alpha(0) := z_h$, $\alpha(1) = z_l$ for some $0 < l := \beta_k(1)$ and $[\alpha * \gamma_l^h] = r \in \pi_1(H, z_h)$ by the construction. Also the map $t \mapsto \pi_z(\alpha(t))$ is decreasing.

Attaching the disc

We will now attach a disc B^2 to H along α (hence it's boundary will correspond to r) so that the resulting space will still be embedded in \mathbb{R}^4 . First we define a map $f: \partial I^2 \rightarrow H$.

Define $f|_{\{0\} \times [1, 1/2]}$ to be path α so that $f(0, 0) = z_h$, define $f|_{\{0\} \times [1/2, 1]}$ to be path γ_l^h so that $f(0, 1) = z_h$ and synchronize both parameterizations so that both paths are injective and $\pi_z f(0, 1/2 - t) = \pi_z f(0, 1/2 + t), \forall t \in [0, 1/2]$. For every choice of $t \in [0, 1]$ define $f(1, t) := (r = 0, z = \pi_z(f(0, t)), w = 0)$. Restating the definition, left side of ∂I^2 is path $\alpha \gamma_{z_l}^{z_h}$ and right side is the projection of $\alpha \gamma_{z_l}^{z_h}$ to axis $\{r = 0, w = 0\}$.

Define the map f on the lower half of I^2 via straight line segments:

$$f(s, t) := s(f(1, t)) + (1 - s)f(0, t) \quad s \in (0, 1), t \in [0, 1/2].$$

Note that $f(I \times \{s\}) \subset \{z = \pi_z(f(0, s))\}$ for any $s \in [0, 1/2]$. Because $t \mapsto \pi_z(\alpha(t))$ is decreasing this means that $f|_{I \times [1, 1/2]}$ is injective.

We will use similar construction for the upper half of I^2 but we do want $f|_{(0, 1)^2}$ to be injective. In order to ensure this we will use fourth dimension w . Let $g: I \times [1/2, 1] \rightarrow I$ be a map with the following properties:

- $g(\partial(I \times [1/2, 1])) = 0$;
- $g(\text{Int}(I \times [1/2, 1])) > 0$;
- $g(x, y) < \pi_z(f(1, y)), \forall x, y$.

The first condition will be required for the continuity of f , the second allows f to be injective on $(0, 1)^2$, and the third one is necessary to maintain compactness of final construction. Define map f on upper half of I^2 with perturbed straight line segments:

$$f(s, t) := s(f(1, t)) + (1 - s)f(0, t) + g(s, t)W \quad s \in (0, 1), t \in [1/2, 1],$$

where W is unit vector along w -axis. The Figure 4.7 visualizes the map f defined in such a manner.

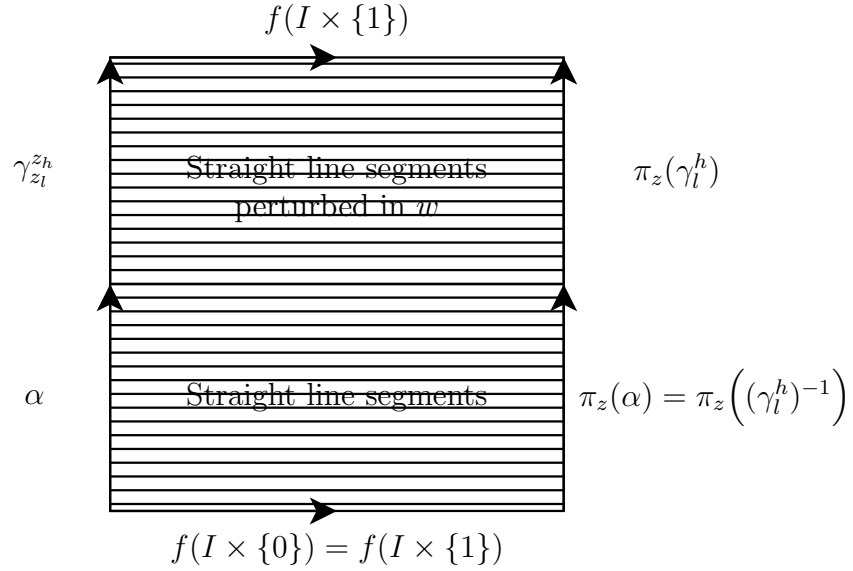

Figure 4.7: Definition of a map f when attaching the disc.

Note that $f|_{(0,1)^2}$ is injective. As mentioned above $f|_{I \times [1,1/2]}$ is injective due to the map $t \mapsto \pi_z(\alpha(t))$ being decreasing. Also $f(I \times [0, 1/2]) \subset \{w = 0\} = \mathbb{R}^3 \times \{0\}$ while all the points of $f((0, 1) \times (1/2, 1))$ have nontrivial w -coordinate by definition hence $f|_{(0,1)^2}$ is injective. Furthermore $f((0, 1) \times [0, 1]) \cap H = \emptyset$. To see it let us analyze line segments $f(I \times \{t\})$. If the φ -coordinate $f((0, t))$ equals zero then $f((0, 1] \times \{t\}) \cap H = \emptyset$ which can be easily seen from Figure 4.1. On other levels $f((0, t))$ is very close to an inner-height where by the definition $f((0, t))$ is the point with smallest r -coordinate in H with given (φ, z) -coordinates. As the line segment ends in the point $(r = 0, z = t, w = 0)$ (so all the points of $f((0, 1] \times \{t\})$ have even smaller r -coordinate) we see that $f((0, 1] \times \{t\}) \cap H = \emptyset$.

We now show that f induces a map f' on B^2 so that $[\partial f'] = [r]$. Notice the equality of restrictions $f|_{I \times \{0\}} = f|_{I \times \{1\}}$. Also synchronized parametrization of $f|_{\{0\} \times I}$ implies equality $f(1, 1/2 - t) = f(1, 1/2 + t), \forall t \in [0, 1/2]$. Identifying $(1, 1/2 - t) \sim (1, 1/2 + t), \forall t \in [0, 1/2]$ and $(t, 0) \sim (t, 1), \forall t \in I$ we obtain quotient space B^2 . It is easy to see that f induces map $f': B^2 \rightarrow \mathbb{R}^4$ with the property $[\partial f'] = r: S^1 \rightarrow H$. Also $f'|_{B^2 - S^1}$

is injective and because H is compact we obtain equality $H \cup f'(B^2) \cong H \cup_r B^2$. ■

Remark. Notice that H is sufficiently nice to use Seifert Van-Kampen theorem to obtain $\pi_1(H \cup_r B^2, x_0) = \langle g_1, g_2, \dots \mid r \rangle$.

4.5 Final Construction

Fix a countable group $G = \langle g_1, g_2, \dots \mid r_1, r_2, \dots \rangle$. Inductive use of 38 will provide us with a compact path connected subspace of \mathbb{R}^4 that has G as fundamental group.

Theorem 39. *For any countable group $G = \langle g_1, g_2, \dots \mid r_1, r_2, \dots \rangle$ there is a compact path connected subspace $X_G \subset \mathbb{R}^4$ so that $\pi_1(X_G, x_0) = G$.*

Proof. We will define space X_G inductively. Start with $X_0 := BHV$ and use 38 to attach B^2 to X_0 via map r_1 within $\{z \in (h_1, 1)\}$ for some $h_1 > 0$ to get X_1 . Proceed by induction: use 38 to attach B^2 to X_k via map r_{k+1} within $\{z \in (h_{k+1}, h_k)\}$ for some $h_{k+1} > 0$ to get X_{k+1} . If there are only finitely many relations halt after finitely many steps, otherwise proceed with infinitely many steps and define $X_G := \cup_i X_i$.

Space X_G is natural subspace of \mathbb{R}^4 and is path connected as every point of X_i is path connected to $x_0 \in X_i, \forall i$. To prove X_G is compact take any Cauchy sequence $\{y_i\}_i$ in X_G . If $\pi_z(y_i)$ converge to $y_z > 0$ then use the fact that $X_G \cap \{z \geq y_z/2\}$ is compact as according to the construction only finitely many walls of braided HV 's in X_0 (heights of braided HV 's are decreasing) and only finitely many attached closed discs B^2 (see (i) of 38) intersect $\{z \geq y_z/2\}$ nontrivially. Both HV 's and discs B^2 are compact hence $X_G \cap \{z \geq y_z/2\}$ is compact therefore $\{y_i\}_i$ has a limit in X_G . If $\pi_z(y_i)$ converge to 0 then note that r -coordinates of all elements are bounded by 3 and w -coordinates of all elements are bounded by their z -coordinates by the definition hence w -coordinate of limit point is 0. Therefore the limit point of $\{y_i\}_i$

is contained in $\{r \leq 3, z = w = 0\}$ which is the pedestal of BHV hence contained in X_G .

The only thing left is to calculate $\pi_1(X_G, x_0)$. Again we will consider Peanification. Using the same argument as above (see 30,37) we see that Peanification of X_G only moves pedestal apart from the wall of H and relations, keeping it attached to the rest of the space only at x_0 . Thus $P(X_G)$ is not compact. We will prove that $[K, P(X_G)] = \cup_i [K, X_i], \forall K$ compact, where $[K, X_i] \subseteq [K, P(X_G)]$ is a subset of those homotopy classes of maps $K \rightarrow P(X_G)$ that have representative mapping $K \rightarrow X_i \subset P(X_G)$. This will mean $[K, X_G] = \cup_i [K, X_i], \forall K$ and hence (substituting K for S^1 or $S^1 \times I$) $\pi_1(X_G, x_0) = \langle g_1, g_2, \dots \mid r_1, r_2, \dots \rangle$ as every loop and every homotopy of $\pi_1(X_G, x_0)$ will be generated by some loop or homotopy of some X_i . Notice that spaces X_i are nice enough to use Seifert Van-Kampen theorem and obtain $\pi_1(X_i, x_0) = \langle g_1, g_2, \dots \mid r_1, r_2, \dots, r_i \rangle$. Therefore the proof is concluded in the case of finitely many relations in the representation of G .

To prove equality $[K, P(X_G)] = \cup_i [K, X_i], \forall K$ for general countable group G take any map $f: K \rightarrow P(X_G)$ and consider $P(X_G) \cap \{r = \varphi = w = 0\}$. For every $i \in \mathbb{Z}^+$ fix a point $x_i \in L_i := B_i^2 \cap \{r = \varphi = w = 0\} \subset \{z \in (h_{i+1}, h_i)\}$, where B_i^2 is B^2 attached in i^{th} step of construction of X_G . Recall from the definition that every B_i^2 intersects $\{r = \varphi = w = 0\}$. Because $\lim_{k \rightarrow \infty} h_k = 0$ the points x_i are converging to $\{z = r = \varphi = w = 0\} \notin P(X_G)$ hence $f(K)$ can only hit finitely many points x_i which implies existence of $j \in \mathbb{Z}^+$ so that $x_i \notin f(K), \forall i > j$. Every point x_i is contained in the interior of B_i^2 and because discs are apart from each other (separated by different zones of z -coordinate they occupy) there are natural strong deformation retractions $(B_i^2 - \{x_i\}) \rightarrow \partial B_i^2 \subset X_j, \forall i > j$ which induce homotopy of f to a map $f': K \rightarrow X_j$. ■

Bibliography

- [1] N. Brodsky, J. Dydak, B. Labuz, and A. Mitra (2008): *Covering maps for locally path connected spaces*, arXiv:0801.4967v3.
- [2] S.Ferry (1980) : *Homotopy, simple homotopy and compacta*, Topology 19 (1980), no. 2, 101–110.
- [3] A. Hatcher, *Algebraic Topology*, Cambridge university press, 2002.
- [4] J.E. Keesling, Y.B. Rudyak (2007): *On fundamental groups of compact Hausdorff spaces*, Proc. Amer. Math. Soc. 135 (2007), no. 8, 2629-2631.
- [5] J. Pawlikowski (1998): *The fundamental group of a compact metric space*, Proc. of the AMS, Vol. 126, No. 10, 3083-3087.
- [6] A. Przeździecki (2006): *Measurable cardinals and fundamental groups of compact spaces*, Fund. Math. 192 (2006), no. 1, 87-92.
- [7] S. Shelah (1988): *Can the Fundamental (Homotopy) Group of a Space be the Rationals?*, Proc. of the AMS, Vol. 103, No. 2, 627-632 .
- [8] Ž. Virk (2009): *Small loop space*, in preparation.
- [9] Ž. Virk (2009): *Realizations of countable groups as fundamental groups of compacta*, in preparation.

Vita

Ziga Virk was born in Ljubljana, Slovenia, at the time former Yugoslavia. He studied mathematics at University of Ljubljana, graduating with bachelor's degree in 2005. In summer 2005 he started graduate studies at at University of Ljubljana. Since summer 2006 he pursued a PhD in mathematics at the University of Tennessee, Knoxville with concentration in topology and geometry, graduating in August 2009.